

COMPRESSOR

DALGAKIRAN



JOURNEY OF AIR

This line represents the standard we have set at many points.

Actually, It's an endless journey, and whatever the conditions,
we will accompany you throughout this journey.

As Dalgakiran, we understand all your needs for high quality compressed air
and offer products and services that will provide maximum added value to you
and your processes with our quality standards and advanced engineering
approach with our productive and dynamic teammates.

D/ALG/KIR/AN



ABOUT US

Türkiye's largest manufacturer and exporter of industrial compressors, Dalgakiran Kompresör was founded in Istanbul in 1965 by Ömer Dalgakiran in a modest workshop measuring 25 m². Dalgakiran Kompresör has grown rapidly since the day it was founded through the investments it made and today owns the compressor production plant with more than a total closed area covering 70.000 m².

As one of Türkiye's top 500 exporters, it reliably exports compressors to more than 130 countries and continues to work, invest, and grow for the improvement of industry and economy.



Continuing to work in the globalizing market focused on customer satisfaction with more than 55 years of experience and a dynamic staff, Dalgakıran provides rapid service all over the world through its 150+ international dealerships, overseas branches, and extensive service network.

DALGAKIRAN

Since
1965

A big Family
900+

Total Closed Area
70.000+ m²

Global Presence
130+ Countries

In 5 Countries
23+ Locations

COMPRESSOR RANGE

Dalgakiran manufactures to suit your compressed air needs with a wide range product portfolio.

Our compressors are designed to provide maximum uptime and reliability with a low total cost of ownership.

We provide the specific requirements of each industry. Our air compressors ensure all industry-specific demands such as cost-efficiency, robustness and easy serviceability.



ROTARY SCREW, RECIPROCATING, SCROLL, TURBO



JOURNEY
OF
AIR

ROTARY SCREW & SCROLL COMPRESSORS

INDEX

Tidy	8
DVK	10
DVK-D	12
Inversys Plus	14
Impetus 22-75	16
Impetus 90-315	20
DS Scroll	24
Eagle	26



315



IMPETUS

**WATER
COOLED** 

**HEAT
RECOVERY** 

0,38-6,40
m³/min

2,2-37
kW

7,5-10-13
bar



General Features

- High quality screw block and motor
- Electronic control
- Easy installation and quick implementation thanks to its compact design



Advantages

- Service-friendly design minimizes downtime and reduces maintenance costs.
- Models with tanks and integrated dryers are compact and take up little space leaving room for other machinery.



Screw Block

- Durable screw block provides high-capacity of air and is specially selected for each model's capacity requirement
- New rotor profiles for reduced loss air production and lower torque requirements
- Next gen bearing design for improved load bearing capabilities



Main Motor and Drive System

- IE3 efficiency-class electric motor
- Star/delta motor starter
- Soft start option
- Belt-pulley drive system
- Easy-to-use belt tensioner and pulley bushing for easy servicing

Model	Pressure		Capacity*		Motor kW/HP	Connection	Dimensions [Width x Length x Height] (mm)		Weight (kg)	
	bar	psi	m ³ /min	cfm			Base Mounted	Tank + Dryer	Base Mounted	Tank + Dryer
TIDY 3	7,5	110	0,38	13,4	2,2/3	G 1/2"	900 x 550 x 860	1834x 550 x 1335	167	288
TIDY 4	7,5	110	0,41	14,5	3/4	G 1/2"	900 x 550 x 860	1834x 550 x 1335	159	290
	10	145	0,36	12,7						
TIDY 5	7,5	110	0,56	19,8	4/5,5	G 1/2"	900 x 550 x 860	1834 x 550 x 1335	175	306
	10	145	0,46	16,3						
	13	190	0,35	12,3						
TIDY 7	7,5	110	0,8	28,3	5,5/7,5	G 1/2"	1050 x 550 x 835	1425 x 550 x 1310	197	328
	10	145	0,65	23						
	13	190	0,53	18,7						
TIDY 10	7,5	110	1,15	40,6	7,5/10	G 3/4"	1050 x 550 x 835	1912 x 640 x 1612	205	408
	10	145	0,95	33,6						408
	13	190	0,77	27,2						437
TIDY 15	7,5	110	1,7	60	11/15	G 3/4"	1217 x 650 x 915	1915 x 655 x 1605	274	477
	10	145	1,4	49,5						477
	13	190	1,16	41						506
TIDY 20	7,5	110	2,25	79,5	15/20	G 3/4"	1217 x 670 x 915	1915 x 655 x 1605	305	510
	10	145	1,96	69,2						510
	13	190	1,61	56,9						539
TIDY 20 B	7,5	110	2,7	95,4	15/20	G 1"	1276 x 850 x 1435	-	420	-
	10	145	2,3	81,2						-
	13	190	1,9	67,1						-
TIDY 25	7,5	110	3,3	116,6	18,5/25	G 1"	1276 x 850 x 1435	-	465	-
	10	145	2,8	98,9						-
	13	190	2,4	84,8						-
TIDY 30	7,5	110	3,8	134,2	22/30	G 1"	1276 x 850 x 1435	-	510	-
	10	145	3,5	123,6						-
	13	190	3	106						-
TIDY 40	7,5	110	4,6	162,5	30/40	G 1 1/4"	1610 x 1030 x 1755	-	698	-
	10	145	4	141,3						-
	13	190	3,6	127,1						-
TIDY 40 B	7,5	110	5,2	183,7	30/40	G 1 1/4"	1610 x 1030 x 1755	-	710	-
	10	145	4,3	151,9						-
	13	190	3,7	130,7						-
TIDY 50	7,5	110	6,4	226	37/50	G 1 1/4"	1610 x 1030 x 1755	-	740	-
	10	145	5,4	190,7						-
	13	190	4,3	151,9						-

- Unit performances measured in reference conditions which are 1 bar absolute air Pressure, %0 relative humidity, 20°C inlet air temperature, 71°C thermostatic valve set temperature and use of Smartoil.

- Dalgakiran reserves its rights to make changes in its products and specifications without prior notice.

* Refers to free air delivery measured according to ISO 1217:2009, Annex C standard.

5,4-27,4
m³/min

45-160
kW

7,5-10-13
bar



General Features

- High-quality, easy-to-replace components with a long service life
- Next gen screw block and motor
- Electronic control
- Soft starter (optional)
- Water cooling (optional)
- Integrated dryer and heat recovery (optional)
- Food grade oil suitable for food production (optional)



Advantages

- Easily accessible parts for reduced maintenance costs.
- Protective covers can be removed and fitted quickly for easy servicing.
- Controllers allow ease of access and use.





Screw Block

- Specially selected, durable screw blocks for different capacity needs
- New rotor profiles for reduced loss air production and lower torque requirements
- Next gen bearing design for improved load resistance capabilities

Model	Pressure		Capacity*		Motor kW/HP	Connection	Dimensions (mm)			Weight kg
	bar	psi	m ³ /min	cfm			Width	Length	Height	
DVK 60	7,5	110	7,2	254	45/60	G 1 1/4"	1605	1030	1755	878
	10	145	6,4	226						
	13	190	5,4	191						
DVK 75	7,5	110	9,6	339	55/75	G 1 1/2"	2065	1200	1810	1371
	10	145	8,5	300						
	13	190	6,6	233						
DVK 100	7,5	110	12,4	438	75/100	G 1 1/2"	2065	1200	1810	1408
	10	145	10,5	371						
	13	190	8,7	307						
DVK 125	7,5	110	15,8	558	90/125	G 2"	2525	1440	2040	2240
	10	145	13,5	477						
	13	190	11	388						
DVK 150	7,5	110	18,8	664	110/150	G 2"	2525	1440	2040	2500
	10	145	16,5	583						
	13	190	14	495						
DVK 180	7,5	110	22,8	805	132/180	G 2 1/2"	2500	1805	2000	2873
	10	145	19,5	689						
	13	190	16	565						
DVK 220	7,5	110	27,4	968	160/220	G 2 1/2"	2500	1805	2000	3030
	10	145	23	812						
	13	190	19,5	689						

- Unit performances measured in reference conditions which are 1 bar absolute air Pressure, %0 relative humidity, 20°C inlet air temperature, 71°C thermostatic valve set temperature and use of Smartoil.
- Dalgakiran reserves its rights to make changes in its products and specifications without prior notice.
- * Refers to free air delivery measured according to ISO 1217:2009, Annex C standard.

3,60-53
m³/min

22-315
kW

7,5-10-13
bar



General Features

- High-quality, easy-to-replace components with a long service life
- Continuous operation for minimum stops
- Next gen screw block and motor
- Electronic control
- Integrated dryer (132 kW and below)
- Water cooled and heat recovery (optional)
- Food grade oil option suitable for food production



Advantages

- Advanced screw block and direct coupled motor ensure saving and high performance by minimizing power transmission losses.
- Service-friendly design reduces maintenance costs.
- Controllers allow ease of access and use.





Screw Block

- A durable and specially selected screw block that provides high capacity air according to the capacity needs of each model
- New rotor profiles for production with reduced losses and lower torque requirements
- Next gen bearing design for improved load bearing capabilities
- Direct coupling

Model	Pressure		Capacity*		Motor kW/HP	Connection	Dimensions (mm)			Weight kg
	bar	psi	m ³ /min	cfm			Width	Length	Height	
DVK 30 D	7,5	110	4	141	22/30	G 1"	1280	850	1435	538
	10	145	3,6	127						
DVK 40 B D	7,5	110	5,5	194	30/40	G 1 1/4"	1635	1030	1755	747
	10	145	4,5	159						
	13	190	3,9	138						
DVK 50 D	7,5	110	6,6	233	37/50	G 1 1/4"	1635	1030	1755	869
	10	145	5,6	198						
	13	190	4,6	163						
DVK 60 B D	7,5	110	8,5	300	45/60	G 1 1/2"	2065	1200	1810	1203
	10	145	7,1	251						
	13	190	5,9	208						
DVK 75 D	7,5	110	9,8	346	55/75	G 1 1/2"	2065	1200	1810	1387
	10	145	8,7	307						
	13	190	7	247						
DVK 100 D	7,5	110	12,6	445	75/100	G 1 1/2"	2065	1200	1810	1424
	10	145	11	388						
	13	190	9,2	325						
DVK 125 D	7,5	110	16,2	572	90/125	G 2"	2525	1440	2040	2240
	10	145	13,7	484						
	13	190	11,2	396						
DVK 150 D	7,5	110	19,5	688	110/150	G 2"	2525	1440	2040	2640
	10	145	17,9	632						
	13	190	14	494						
DVK 180 D	7,5	110	23,4	826	132/180	G 2 1/2"	2775	1805	2000	2970
	10	145	20	706						
	13	190	16,5	583						
DVK 220 D	7,5	110	28	989	160/220	G 2 1/2"	2775	1805	2000	3080
	10	145	23,5	830						
	13	190	20	706						
DVK 270 D	7,5	110	37	1307	200/270	DN80	3290	2285	2455	5300
	10	145	30,8	1088						
	13	190	24,5	865						
DVK 340 D	7,5	110	45	1590	250/340	DN100	3315	2285	2455	5600
	10	145	38,6	1363						
	13	190	32,6	1151						
DVK 430 D	7,5	110	53	1872	315/430	DN100	3315	2285	2455	5920
	10	145	45,5	1607						
	13	190	39,5	1395						

- Unit performances measured in reference conditions which are 1 bar absolute air Pressure, %0 relative humidity, 20°C inlet air temperature, 71°C thermostatic valve set temperature and use of Smartoil.

- Dalgakiran reserves its rights to make changes in its products and specifications without prior notice.

* Refers to free air delivery measured according to ISO 1217:2009, Annex C standard.



0,36-54,10
m³/min

5,5-315
kW

7,5-10-13
bar



Advantages

- Up to 65% energy saving*
- Operation at constant output pressure value
- Wide operating pressure range (5-14 bar)**
- Long component life cycle thanks to soft start
- Protection against the adverse effects of peak currents
- Effective and energy efficient compressed air production even in case of highly variable compressed air requirements

* When compared with compressors without an inverter for applications with variable requirements

** If requested, it is produced specially according to the need.



Main Motor and Drive System

- IE3 efficiency-class electric motor
- Direct coupled (1:1)
- Elasting coupling for a maintenance free long-lasting and efficient power transmission system
- Variable-speed starting with frequency converter
- High temperature protection for motor bearings (Inversys 15-315 Plus)



Screw Block

- A durable and specially selected patented screw block that provides high capacity air according to the capacity needs of each model
- New rotor profiles for reduced loss air production
- Next gen bearing design for improved load bearing capabilities

Model	Pressure		Capacity*				Motor (kW/HP)	Connection	Dimensions [Width x Length x Height] (mm)		Weight (kg)	
	bar	psi	Minimum m ³ /min	Minimum cfm	Maximum m ³ /min	Maximum cfm			Base Mounted	Tank + Dryer	Base Mounted	Tank + Dryer
INVERSYS 5 PLUS	7,5	110	0,38	13,4	1,03	36	5,5/7,5	G 1/2"	1058 x 650 x 963	1828 x 650 x 1438	235	366
	10	145	0,37	13	0,83	29						
	13	190	0,36	12,7	0,64	22,6						
INVERSYS 7 PLUS	7,5	110	0,42	14,8	1,4	49,4	7,5/10	G 1/2"	1058 x 650 x 963	1828 x 650 x 1438	273	436
	10	145	0,43	15,1	1,2	42,3						
	13	190	0,43	15,1	0,95	33,5						
INVERSYS 11 PLUS	7,5	110	0,77	27	1,8	64	11/15	G 3/4"	1200 x 730 x 1050	1911 x 730 x 1708	320	533
	10	145	0,81	29	1,61	57						533
	13	190	0,74	26	1,3	46						590
INVERSYS 15 PLUS	7,5	110	0,79	28	2,85	101	15/20	G 3/4"	1200 x 730 x 1050	1911 x 730 x 1708	420	638
	10	145	0,77	27	2,33	82						638
	13	190	0,99	35	2,07	73						658
INVERSYS 18 PLUS	7,5	110	1,1	39	3,5	124	18,5/25	G 1"	1280 x 860 x 1435	-	500	-
	10	145	1	35	3	106						-
	13	190	1,1	39	2,6	92						-
INVERSYS 22 PLUS	7,5	110	1,3	46	4,2	148	22/30	G 1"	1280 x 860 x 1435	-	516	-
	10	145	1,3	46	3,8	134						-
	13	190	1,2	42	3	106						-
INVERSYS 30 PLUS	7,5	110	1,2	43	5,3	187	30/40	G 1 1/4"	1605 x 1040 x 1755	-	819	-
	10	145	1,2	43	4,6	162						-
	13	190	1,2	43	4	141						-
INVERSYS 37 PLUS	7,5	110	1,3	46	6,8	240	37/50	G 1 1/4"	1605 x 1040 x 1755	-	870	-
	10	145	1,3	46	5,8	205						-
	13	190	1,3	46	5	177						-
INVERSYS 45 PLUS	7,5	110	1,3	46	7,6	268	45/60	G 1 1/4"	1605 x 1040 x 1755	-	945	-
	10	145	1,2	42	6,8	240						-
	13	190	1,2	42	5,9	208						-
INVERSYS 55 PLUS	7,5	110	2,5	88	9,9	350	55/75	G 1 1/2"	2065 x 1200 x 1810	-	1524	-
	10	145	2,4	85	8,2	290						-
	13	190	2,6	92	7,4	261						-
INVERSYS 75 PLUS	7,5	110	2,6	92	12,9	456	75/100	G 1 1/2"	2065 x 1200 x 1810	-	1647	-
	10	145	2,5	88	10,9	385						-
	13	190	2,5	88	9,6	339						-
INVERSYS 90 PLUS	7,5	110	6,2	219	16,8	593	90/125	G 2"	2525 x 1440 x 2037	-	2020	-
	10	145	6	212	14,4	509						-
	13	190	6,2	219	12,3	434						-
INVERSYS 110 PLUS	7,5	110	6,6	233	20,1	710	110/150	G 2"	2525 x 1440 x 2037	-	2380	-
	10	145	7,1	250	17,3	611						-
	13	190	7	247	15	530						-
INVERSYS 132 PLUS	7,5	110	6,9	244	24,3	858	132/180	G 2 1/2"	2775 x 1820 x 2000	-	2555	-
	10	145	6,8	240	20,3	717						-
	13	190	9,7	343	18,1	639						-
INVERSYS 160 PLUS	7,5	110	6,8	240	28,2	996	160/220	G 2 1/2"	2775 x 1820 x 2000	-	2760	-
	10	145	7,1	251	24,6	869						-
	13	190	8,5	300	21,7	766						-
INVERSYS 200 PLUS	7,5	110	14	494	37,5	1324	200/270	DN80	3290 x 2285 x 2455	-	4460	-
	10	145	13,9	491	32,3	1141						-
	13	190	13,8	487	28,8	1017						-
INVERSYS 250 PLUS	7,5	110	13,6	480	45,2	1596	250/340	DN100	3315 x 2285 x 2455	-	5600	-
	10	145	13,5	477	38,5	1360						-
	13	190	13,5	477	33,5	1183						-
INVERSYS 315 PLUS	7,5	110	13,2	466	54,1	1911	315/430	DN100	3315 x 2285 x 2455	-	6000	-
	10	145	13,2	466	44,3	1564						-
	13	190	12,9	456	38	1342						-

- Unit performances measured in reference conditions which are 1 bar absolute air Pressure, %0 relative humidity, 20°C inlet air temperature, 71°C thermostatic valve set temperature and use of Smartoil.

- Dalgakiran reserves its rights to make changes in its products and specifications without prior notice.

* Refers to free air delivery measured according to ISO 1217:2009, Annex E standard.

4,3-16
m³/min

22-75
kW

7,5-8,5-10
bar



General Features

- IE5 efficiency-class IPM electric motors
- Two-stage screw block
- Water cooling (37 kW and above)
- Soft start with variable speed power transmission
- Operating with low noise level
- Integrated dryer (optional)
- Heat recovery (optional)



Electric Motor Drive

- The drive and IMP meet the requirements of IES2 (EN50598)
- Functionality in a single unit
- Uses fewer components
- Long service life helps to minimize environmental impact.

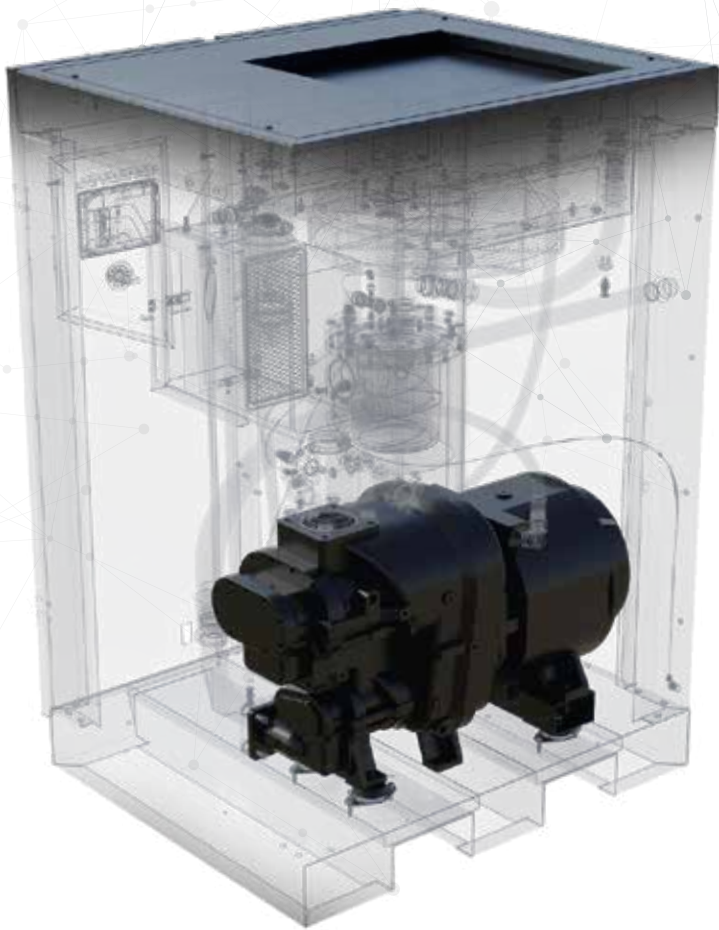

Electric Motor

- Ultra Premium IE5 energy efficiency-class electric motors
- Internal Permanent Magnet Motor (IPM)
- Compact design
- F-class insulation
- Optimum oil cooling at all speeds for high efficiency
- Low noise levels
- Grease-free lubricated motor bearings



Cooling System

- High cooling efficiency in compact air and oil heat exchangers
- Suitable design for operating up to 45°C
- Radial fan for high cooling efficiency (37 kW and above)
- Low noise level with low speed radial fans
- Cooling fan driver for maximum energy efficiency



Screw Block

- Two-stage screw block produces energy efficiency by up to 10%
- Higher flow rate by up to 10%.
- Thanks to low compression rate low axial and compression forces
- Zero transmission losses by compact direct power transmission
- No requirement for a power transmission element results in a compact design
- Low axial and compression forces due to low compression ratio between screw blocks
- Thanks to low rotor speeds, a long service life
- Thanks to two-stage compression, low noise and vibration levels



Intake Chamber

- High acoustic performance in noise dampening
- Insulated cold air intake for energy efficiency



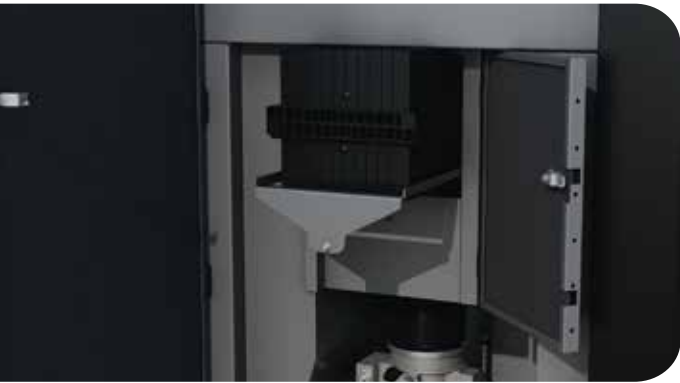

Air Filter

- Two-stage filtration (Initial filtration/precision filtration)
- 99.9% efficiency in particle separation down to microns
- Low pressure loss (starting pressure fall < 3mbar)
- Easy maintenance
- Long service life



Oil Filter

- Non-metallic, environmentally friendly and recyclable oil filter
- Aluminium housing
- Easy maintenance
- Compact design



Separator System

- Effective separator elements keep the amount of oil in the outlet air low (1-3 mg/m³) for high-quality compressed air
- Sep-n-sep type separator with enlarged surface area
- Easy to service
- High efficiency three stage air-oil separation system



Water Separator

- Compact, integrated and unique design
- Separation performance is %99 even in very hot and humid conditions
- High energy efficiency with minimal pressure loss

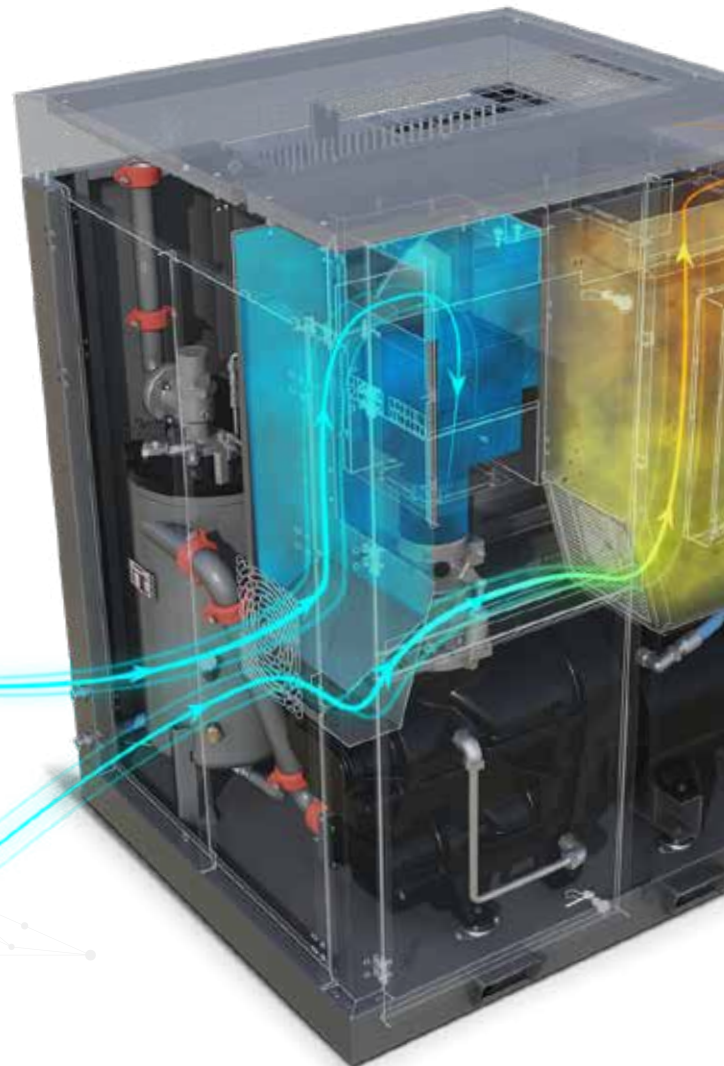

Model	Pressure		Capacity*				Motor Power	Connection Size	Dimensions (mm)			Weight	Noise
			Minimum		Maximum				Length	Width	Height		
	bar	psi	m ³ /min	cfm	m ³ /min	cfm	kg					dB (A)	
IMPETUS VSD 22	7,5	110	1,02	36	4,35	154	22/30	G 1 1/4"	955	1095	1580	750	72
	8,5	125	1,04	37	4,17	147			955	1095	1580		
	10	145	1,03	36	3,76	133			955	1095	1580		
IMPETUS VSD 30	7,5	110	1,63	58	6,36	225	30/40	G 1 1/4"	955	1095	1580	875	72
	8,5	125	1,60	57	5,91	209			955	1095	1580		
	10	145	1,57	55	5,41	191			955	1095	1580		
IMPETUS VSD 37	7,5	110	1,77	63	7,76	274	37/50	G 1 1/2"	1195	1250	1860	1220	71
	8,5	125	1,77	63	7,27	257			1195	1250	1860		
	10	145	1,76	62	6,52	230			1195	1250	1860		
IMPETUS VSD 45	7,5	110	2,30	81	9,30	329	45/60	G 1 1/2"	1195	1250	1860	1400	72
	8,5	125	2,28	80	8,73	308			1195	1250	1860		
	10	145	2,27	80	8,01	283			1195	1250	1860		
IMPETUS VSD 55	7,5	110	2,60	92	11,60	410	55/75	G 2"	1400	1450	1965	1620	72
	8,5	125	2,54	90	10,85	383			1400	1450	1965		
	10	145	2,53	89	9,54	337			1400	1450	1965		
IMPETUS VSD 75	7,5	110	3,51	124	16,01	565	75/100	G 2"	1400	1450	1965	1850	72
	8,5	125	3,63	128	15,27	539			1400	1450	1965		
	10	145	3,57	126	13,22	467			1400	1450	1965		

- Unit performances measured in reference conditions which are 1 bar absolute air Pressure, %0 relative humidity, 20°C inlet air temperature, 71°C thermostatic valve set temperature and use of Smartoil.
- Dalgakiran reserves its rights to make changes in its products and specifications without prior notice.
- * Refers to free air delivery measured according to ISO 1217:2009, Annex E standard.

5,1-62,3
m³/min

90-315
kW

7,5-8,5
10-13
bar



General Features

- IE4 efficiency-class electric motors
- Two-stage screw block
- Variable and fixed speed motor power options
- Water cooling and heat recovery (optional)
- Operating with low noise level



Screw Block

- Two-stage screw block produces energy efficiency by up to 10%
- Higher flow rate by up to 10% comparing to single stage
- Direct coupled
- Reduced internal losses
- Thanks to low compression rate, low axial and compression forces
- Thanks to low rotor speeds, a long service life
- With two-stage compression near isothermal compression
- Reduced axial and compression forces resulting in longer screw and bearing service life

Electric Motor

- IE4 efficiency-class electric motors
- B-class temperature increase
- Continuous operating feature



Intake Chamber

- Intake in cold air directly from the environment contributes to energy efficiency by up to 2%
- High energy efficiency with minimized intake pressure losses
- Improved acoustic designs result in low noise levels

Cooling System

- High cooling efficiency in compact air and oil heat exchangers
- Suitable design for operating up to 45°C
- Low noise level with low speed radial fans
- Energy efficiency with optimum oil temperature thanks to VSD-controlled radial fans

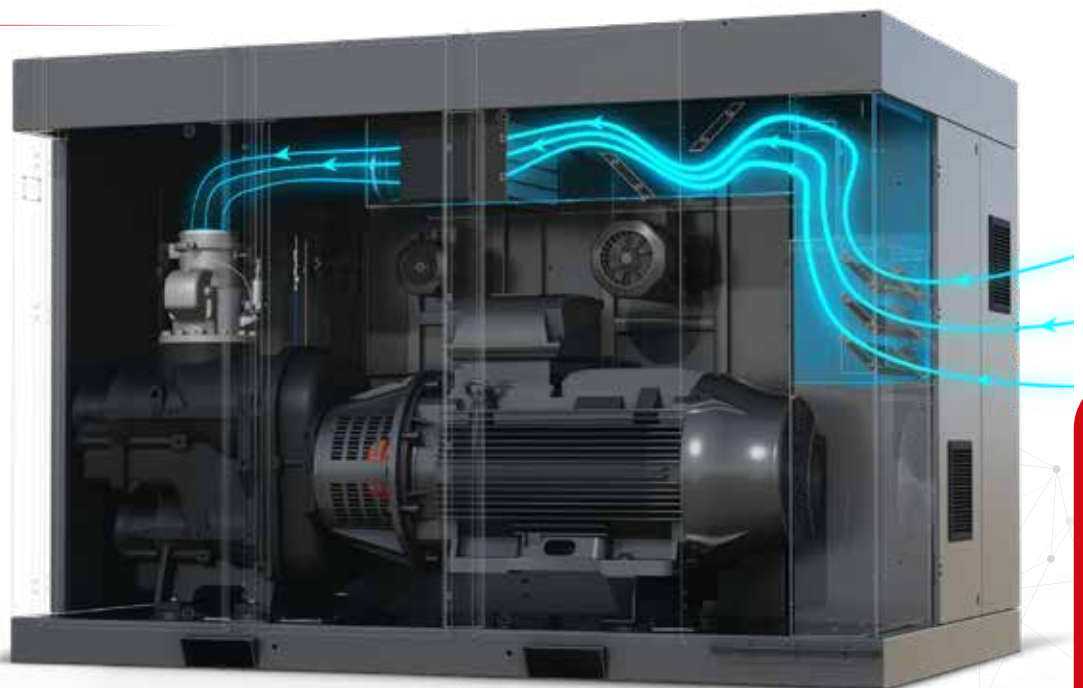

Model	Pressure		Capacity*		Motor kW/HP	Connection Size	Dimensions (mm)			Weight kg	Noise dB (A)
	bar	psi	m ³ /min	cfm			Length	Width	Height		
IMPETUS 90	7,5	110	18,42	650	90/125	DN65	2775	1805	1926	3660	75
	8,5	125	14,72	520							
	10	145	14,65	517							
	13	190	13,65	482							
IMPETUS 110	7,5	110	23,89	844	110/150	DN65	2775	1805	1926	4000	75
	8,5	125	21,76	768							
	10	145	18,49	653							
	13	190	14,57	515							
IMPETUS 132	7,5	110	26,25	927	132/180	DN80	2950	1950	2000	4500	75
	8,5	125	26,07	921							
	10	145	23,62	834							
	13	190	21,82	771							
IMPETUS 160	7,5	110	31,72	1120	160/220	DN80	2950	1950	2000	5000	76
	8,5	125	31,29	1105							
	10	145	25,78	910							
	13	190	25,60	904							
IMPETUS 200	7,5	110	43,49	1536	200/270	DN 100	3500	2250	2350	6220	78
	8,5	125	40,70	1437							
	10	145	34,77	1228							
	13	190	30,62	1081							
IMPETUS 250	7,5	110	53,40	1886	250/340	DN 100	3500	2250	2350	9120	79
	8,5	125	50,49	1783							
	10	145	43,15	1524							
	13	190	40,53	1431							
IMPETUS 315	7,5	110	62,67	2213	315/430	DN 100	3500	2250	2350	9400	80
	8,5	125	56,95	2011							
	10	145	55,18	1949							
	13	190	44,13	1558							

- Unit performances measured in reference conditions which are 1 bar absolute air Pressure, %0 relative humidity, 20°C inlet air temperature, 71°C thermostatic valve set temperature and use of Smartoil.

- Dalgakiran reserves its rights to make changes in its products and specifications without prior notice.

* Refers to free air delivery measured according to ISO 1217:2009, Annex E standard.

Model	Pressure		Capacity*				Motor Power	Connection Size	Dimensions (mm)			Weight	Noise
			Minimum		Maximum				Length	Width	Height		
	bar	psi	m ³ /min	cfm	m ³ /min	cfm	kg					dB (A)	
IMPETUS VSD 90	7,5	110	5,38	189	18,44	651	90/125	DN65	2775	1805	1926	3835	75
	8,5	125	5,36	189	17,33	612							
	10	145	5,24	185	15,87	560							
	13	190	5,15	181	13,66	482							
IMPETUS VSD 110	7,5	110	7,08	250	23,12	816	110/150	DN65	2775	1805	1926	4200	75
	8,5	125	6,9	243	21,68	766							
	10	145	6,88	242	20,2	713							
	13	190	6,82	240	17,25	609							
IMPETUS VSD 132	7,5	110	7,94	280	27,88	985	132/180	DN80	2950	1950	2000	4675	75
	8,5	125	7,9	278	26,4	932							
	10	145	7,59	268	24,51	866							
	13	190	7,5	264	21,35	754							
IMPETUS VSD 160	7,5	110	8,5	299	32,45	1146	160/220	DN80	2950	1950	2000	5300	76
	8,5	125	8,25	291	30	1059							
	10	145	8,39	296	28	989							
	13	190	9,14	322	24,98	882							
IMPETUS VSD 200	7,5	110	11,8	416	42,86	1514	200/270	DN 100	3500	2250	2350	6550	78
	8,5	125	11,8	416	39,94	1410							
	10	145	11,6	410	37,01	1307							
	13	190	11,4	402	30,54	1079							
IMPETUS VSD 250	7,5	110	17,34	612	52,41	1851	250/340	DN 100	3500	2250	2350	9400	79
	8,5	125	17,12	604	49,13	1735							
	10	145	16,76	591	45,86	1620							
	13	190	17,33	612	38,84	1372							
IMPETUS VSD 315	7,5	110	16,86	595	62,01	2190	315/430	DN 100	3500	2250	2350	9680	80
	8,5	125	16,85	595	59,31	2095							
	10	145	16,81	593	55,24	1951							
	13	190	30,33	1071	45,96	1623							

- Unit performances measured in reference conditions which are 1 bar absolute air Pressure, %0 relative humidity, 20°C inlet air temperature, 71°C thermostatic valve set temperature and use of Smartoil.
- Dalgakiran reserves its rights to make changes in its products and specifications without prior notice.
- * Refers to free air delivery measured according to ISO 1217:2009, Annex E standard.

0,16-3,40
m³/min

1,5-30
kW

8-10
bar



General Features

- Compact design
- Soundproofed canopy
- Internal air cooler(s), water separator and stainless pipes
- Robust and durable single unit or stacked design

Advantages

- Low noise level thanks to low-vibration operation.
- User-friendly, robust and long-lasting microprocessor control device with communication features based on the product
- Smooth operation and interruption-free production.
- Component placement specifically designed to reduce downtimes during maintenance process.



	Model	Pressure		Capacity		Motor	Connection	Dimensions (mm) [Width x Length x Height]			Weight (kg)		
		bar	psi	m³/min	cfm	kW/HP		Base Mounted	Tank Mounted	Tank + Dryer	Base Mounted	Tank Mounted	Tank + Dryer
SINGLE	DS1.5-S	8	115	0,16	5,65	1,5 / 2	G 1/2"	750x731x900	1773x823x1381	1818x823x1381	195	329	372
	DS2.2-S	8	115	0,24	8,48	2,2 / 3	G 1/2"	750x731x900	1773x823x1381	1818x823x1381	200	334	377
		10	145	0,2	7,06								
	DS3.7-S	8	115	0,4	14,13	3,7 / 5,5	G 1/2"	750x731x900	1773x823x1381	1818x823x1381	220	354	397
		10	145	0,34	12,01								
DS5.5-S	8	115	0,6	21,19	5,5 / 7,5	G 1/2"	750x731x900	1773x823x1381	1818x823x1381	230	364	407	
	10	145	0,47	16,6									
DS7.5-S	8	115	0,85	30,01	7,5 / 10	G 1/2"	750x731x900	1773x823x1381	1818x823x1428	235	369	431	
	10	145	0,68	24,01									
DOUBLE	DS7,5-D	8	115	0,8	28,25	2x(3,7 / 5,5)	G 3/4"	1500x821x1050	1972x926x1725	-	405	590	-
		10	145	0,68	24,01								
	DS11-D	8	115	1,2	42,38	2x(5,7 / 7,5)	G 3/4"	1500x821x1050	1972x926x1725	-	425	610	-
10		145	0,94	33,2									
DS15-D	8	115	1,7	60,03	2x(7,5 / 10)	G 3/4"	1500x821x1050	1972x926x1725	-	440	625	-	
	10	145	1,36	48,02									
TRIPLE	DS11-T	8	115	1,2	42,38	3x(3,7 / 5,5)	G 1"	1500x823x1840	-	-	540	-	-
		10	145	1,02	36,02								
	DS16,5-T	8	115	1,8	63,57	3x(5,7 / 7,5)	G 1"	1500x823x1840	-	-	615	-	-
10		145	1,41	49,79									
DS22.5-T	8	115	2,55	90,05	3x(7,5 / 10)	G 1"	1500x823x1840	-	-	625	-	-	
	10	145	2,04	72,04									
QUADRUPLE	DS15-Q	8	115	1,6	56,5	4x(3,7 / 5,5)	G 1"	1500x823x1840	-	-	645	-	-
		10	145	1,36	48,03								
	DS22-Q	8	115	2,4	84,75	4x(5,7 / 7,5)	G 1"	1500x823x1840	-	-	745	-	-
		10	145	1,88	66,39								
	DS30-Q	8	115	3,4	120,07	4x(7,5 / 10)	G 1"	1500x823x1840	-	-	755	-	-
		10	145	2,72	96,06								

- Unit performances measured in reference conditions which are 1 bar absolute air Pressure, %0 relative humidity, 20°C inlet air temperature, 71°C thermostatic valve set temperature and use of Smartoil.
- Dalgakiran reserves its rights to make changes in its products and specifications without prior notice.

3,8-48,8
m³/min

37-315
kW

7-8,5-10
bar



General Features

- IE4 efficiency-class electric motors
- Soundproofed canopy
- Electrostatic coated canopy components for high corrosion resistance
- Electric motor protection to prevent overload
- Air-cooled and water-cooled options available
- Fixed and variable speed drive options
- Soft starting at variable speed models
- Soft starter at fixed speed models
- Direct coupled drive system



Advantages

- Eco-friendly technology.
- It can be used safely in sensitive industries such as food and pharmaceutical for the highest hygiene.
- Highly durable performance suitable for working in the harshest operational conditions.
- Models with VSD technology save up to 65% energy and reduce your energy costs.
- Special venturi design prevents rapid pressure fluctuations and high-frequency vibrations.





Screw Block

- Two-stage screw block
- Special ultracoated rotors for minimum gap tolerance, high efficiency, high temperature resistance
- Bearing system developed with the latest technology ensures long life and vibration-free operation
- High level sealing system ensures high performance even during long operation periods
- Synchronizing gears for contact-free power transmission between the rotors
- Stainless steel rotors to counter risk of corrosion and locking for a long service life

Cooling System

- Two-stage cooling with stainless steel pipe and finned pre-cooler system
- After-cooler with aluminium bar and plate system
- Easy to maintain and clean
- Washable panel filter
- Optimum in-cabinet air circulation to keep the motor and screw block cool

Water Separator

- Improved design for highly efficient water separation at the cooler outlet with minimum pressure loss
- Energy-efficient and zero-loss electronic drain system drains the water before the compressed air is sent to the dryer



Model	Pressure		Capacity *		Motor kW/HP	Connection	Dimensions (mm) [Air Cooled / Water cooled]		
	bar	psi	m ³ /min.	cfm			Width	Length	Height
EAGLE 37	7	100	6	212	37/50	G 2"	2593	1640	2160
	8,5	125	5,3	187					
	10	145	4,8	170					
EAGLE 45	7	100	7,5	265	45/60	G 2"	2593	1640	2160
	8,5	125	6,5	230					
	10	145	5,9	208					
EAGLE 55	7	100	9,4	332	55/75	G 2"	2593	1640	2160
	8,5	125	8,6	304					
	10	145	7,5	265					
EAGLE 75	7	100	12,7	449	75/100	G 2"	2593	1640	2160
	8,5	125	11,8	417					
	10	145	10,2	360					
EAGLE 90 B	7	100	15,5	547	90/125	DN80	3197	1840	2450/2200
	8,5	125	13	459					
	10	145	13	459					
EAGLE 110	7	100	19,5	689	110/150	DN80	3197	1840	2450/2200
	8,5	125	17,6	622					
	10	145	15,5	547					
EAGLE 132	7	100	22,3	788	132/180	DN80	3197	1840	2450/2200
	8,5	125	20,9	738					
	10	145	19,4	685					
EAGLE 160	7	100	25,4	897	160/220	DN80	3197	1840	2450/2200
	8,5	125	25,3	893					
	10	145	24	848					
EAGLE 185	7	100	28	989	185/250	DN80	3197	1840	2450/2200
	8,5	125	28	989					
	10	145	28	989					
EAGLE 200	7	100	36	1271	200/270	DN100	3797/3544	2140	2715/2450
	8,5	125	34	1200					
	10	145	28,3	999					
EAGLE 250	7	100	44,3	1564	250/340	DN100	3797/3544	2140	2715/2450
	8,5	125	40,5	1430					
	10	145	35,8	1264					
EAGLE 315	7	100	48,7	1720	315/430	DN100	3797/3544	2140	2715/2450
	8,5	125	48,7	1720					
	10	145	44,2	1560					

- Unit performances measured in reference conditions which are 1 bar absolute air Pressure, %0 relative humidity, 20°C inlet air temperature, 71°C thermostatic valve set temperature and use of Smartoil.
- Dalgakiran reserves its rights to make changes in its products and specifications without prior notice.
- Refers to free air delivery measured according to ISO 1217:2009, Annex C standard.

Model	Pressure		Capacity *				Motor kW/HP	Connection	Dimensions (mm) [Air Cooled / Water cooled]		
	bar	psi	Min. m ³ /min	Min. cfm	Max. m ³ /min	Max. cfm			Width	Length	Height
EAGLE 55 VSD	7	100	3,8	134	9,1	321	55/75	G 2"	2588/2593	1640	2160
	8,5	125	3,7	131	8,3	293					
	10	145	3,7	131	7,5	265					
EAGLE 75 VSD	7	100	6,2	219	12,8	452	75/100	G 2"	2588/2593	1640	2160
	8,5	125	6,2	219	11,9	420					
	10	145	6,2	219	11	389					
EAGLE 90 VSD	7	100	6,2	219	14,6	516	90/125	G 2"	2588/2593	1640	2160
	8,5	125	6,2	219	14,2	501					
	10	145	6,2	219	13,2	466					
EAGLE 110 VSD	7	100	9,1	321	18,8	664	110/150	DN80	3197	1840	2450/2200
	8,5	125	10,3	364	18,5	653					
	10	145	10,3	364	17,4	614					
EAGLE 132 VSD	7	100	10,4	367	22,2	784	132/180	DN80	3197	1840	2450/2200
	8,5	125	10,4	367	21	742					
	10	145	10,3	364	19,6	692					
EAGLE 160 VSD	7	100	10,7	378	26,9	950	160/220	DN80	3197	1840	2450/2200
	8,5	125	10,6	374	25,5	901					
	10	145	10,6	374	23,5	830					
EAGLE 185 VSD	7	100	14	494	29,6	1045	185/250	DN80	3197	1840	2450/2200
	8,5	125	14	494	29,5	1042					
	10	145	13,9	491	27,7	978					
EAGLE 200 VSD	7	100	17,4	614	36,2	1278	200/270	DN100	3797/3540	2140	2715/2450
	8,5	125	17,3	611	33,3	1176					
	10	145	17,2	607	30,4	1074					
EAGLE 250 VSD	7	100	18,9	667	44,6	1575	250/340	DN100	3797/3540	2140	2715/2450
	8,5	125	18,8	664	41,3	1458					
	10	145	18,7	660	38,2	1349					
EAGLE 315 VSD	7	100	22,9	809	48,8	1723	315/430	DN100	3797/3540	2140	2715/2450
	8,5	125	22,9	809	46,6	1646					
	10	145	22,9	809	46,3	1635					

- Unit performances measured in reference conditions which are 1 bar absolute air Pressure, %0 relative humidity, 20°C inlet air temperature, 71°C thermostatic valve set temperature and use of Smartoil.

- Dalgakiran reserves its rights to make changes in its products and specifications without prior notice.

* Refers to free air delivery measured according to ISO 1217:2009, Annex E standard.

RECIPROCATING AIR COMPRESSORS

INDEX

DKC	32
D	34
DBK BOOSTER	36
DBK BOOSTER GP	38
PET MASTER	40
DKK	42
WAVE	44





DKK/40

GAKIRAN

205-1657
L/min

1,1-7,5
kW

8-12-15
bar



General Features

- Suitable for operation even in the most challenging ambient conditions
- Easy to use and low noise levels
- Reliable and efficient compressed air production



Advantages

- Reliable operation
- High-quality components for long service life.





Main Motor and Safety System

- IE3 efficiency-class electric motor
- Safe operation with pressure switch, check valve and safety valve
- Belt-pulley guard
- Manometer
- Ready-to-run electrical mechanism

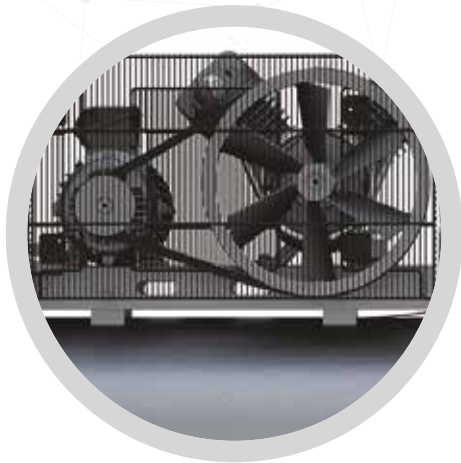

Compressor Block

- Cast iron cylinder body
- Cast iron cylinder heads with cooling channels
- Special aluminium alloy pistons and connecting rod
- Cast iron pulley for fan-type efficient cooling
- Air intake filter
- Splash lubrication
- Oil level gauge
- Factory-filled oil
- Star/delta connectors (5.5 kW and above)
- External control panel (optional)

Model	Working Pressure		Piston Displacement		Motor	Connection	Dimensions (mm)			Weight	Air Receiver
	bar	psi	l/min	cfm	kW/HP		Width	Length	Height	kg	l
SINGLE STAGE											
DKT 100	8	115	205	7.2	1,1/1,5	1/2"	1202	426	894	93	80
DKC 150	8	115	327	11.5	1,5/2,0	1/2"	1202	426	914	106	80
DKC 200	8	115	410	14.5	2,2/3,0	1/2"	1531	450	1037	135	200
DKC 300	8	115	607	21.4	4,0/5,5	1/2"	1830	466	1145	209	250
DKC 500	8	115	1013	35.8	5,5/7,5	3/4"	1934	642	1308	308	500
DKS 600	8	115	1657	58.5	7,5/10	3/4"	1926	668	1413	390	500
DOUBLE STAGE											
DKKC 200	12	175	205	7.2	1,5/2,0	1/2"	1532	450	983	145	200
DKKD 15	15	215	507	17.9	4/5,5	3/4"	1832	474	1097	230	250
DKKD 12	12	175	856	30.2	7,5/10	3/4"	1920	658	1298	374	500
DKKD 15A	15	215	828	29.2	7,5/10	3/4"	1925	669	1406	439	500

- Unit performances measured in reference conditions which are 1 bar absolute air Pressure, %0 relative humidity, 20°C inlet air temperature, 71°C thermostatic valve set temperature and use of Smartoil.

- Dalgakiran reserves its rights to make changes in its products and specifications without prior notice.

145-1766
l/min

1,5-11
kW

7-12,5
bar



General Features

- Reliable design
- Safe to use
- High-quality components and safety systems
- Energy efficient



Advantages

- Offers ideal solutions for small business enterprises.
- Service-friendly design reduces maintenance costs.
- Produces reliable and efficient pressure.
- Uses quality components for a long service life.
- Low noise levels.



Compressor Block

- Cast iron cylinder body
- Aluminium injection-moulded cylinder head
- Special aluminium alloy pistons and connecting rod
- Cast iron pulley for fan-type efficient cooling
- Splash lubrication
- Oil level gauge
- Factory-filled oil
- External star/delta control panel (optional for 7,5 & 11kW)

Model	Working Pressure bar	Piston Displacement l/min	Motor Power kW / HP	Air Connection	Dimensions (mm)			Weight kg	Air Receiver l
					Length	Width	Height		
SINGLE STAGE									
D 2-100 D	7	178	1,5/2	2 x G¼"	450	1100	820	81	100
D 3-200 D	7	290	2,2/3	2 x G¼"	450	1445	965	127	200
D 4-300	7	501	3/4	1 x G¼" + 1 x G¾"	450	1745	1000	147	250
D 5,5-300	7	649	4/5,5	2 x G¼" + 1 x G¾"	450	1745	1030	180	250
D 5,5-500	7	649	4/5,5	2 x G¼" + 1 x G¾"	640	1915	1260	264	500
D 7,5-500	7	971	5,5/7,5	2 x G¼" + 1 x G¾"	640	1915	1350	283	500
D 10-500	7	1222	7,5/10	2 x G¼" + 1 x G¾"	640	1915	1370	297	500
D 15-500	7	1766	11/15	2 x G¼" + 1 x G¾"	700	1840	1520	465	500
DOUBLE STAGE									
D 2-100 MT	12,5	145	1,5/2	2 x G¼"	450	1040	820	86	100
D 3-200 MT	12,5	145	2,2/3	2 x G¼"	450	1445	965	132	200
D 4-300 T	12,5	334	3/4	1 x G¼" + 1 x G¾"	450	1755	1000	167	250
D 5,5-300 T	12,5	324	4/5,5	2 x G¼" + 1 x G¾"	450	1755	1030	198	250
D 5,5-500 T	12,5	324	4/5,5	2 x G¼" + 1 x G¾"	640	1910	1255	330	500
D 7,5-500 T	12,5	647	5,5/7,5	2 x G¼" + 1 x G¾"	640	1910	1275	350	500
D 10-500 T	12,5	726	7,5/10	2 x G¼" + 1 x G¾"	700	1910	1355	365	500

- Dalgakıran reserves its rights to make changes in its products and specifications without prior notice.

2,1-11,68
m³/min

7,5-30
kW

15-40
bar



General Features

- Electric motor protection to prevent overload
- Air-cooled compressor units
- Energy-saving Load/Unload System for efficient operation
- Low speed operation
- Lubrication system with splashing
- Dedicated discharge system to prevent oil discharge from blow-off valve
- Automatic discharge system for loadless start
- Star/delta motor starter
- Soft starter (optional)



Advantages

- Durable sliding bearings prolong maintenance periods and keep maintenance costs low.
- High performance with the high engineering technology and design.
- Oil-trap air filtration system provides cleaner air.
- Energy-saving advanced cooling systems.





Main Motor and Drive System

- Belt pulley drive system,
- Specially designed fan type cast pulley,
- Easy belt tensioning system
- Star/delta motor starter
- Special loadless start system and automatic discharge system for loadless start
- IE3 efficiency-class electric motors

Safety System

- Inlet air regulator
- High-pressure switch
- Manual condensate drainage valve
- Integrated check valve at air outlet line
- Outlet pressure manometer
- High pressure safety valve
- Oil pressure control
- Integrated particulate filter at inlet air line
- By-pass line for protection against high oil pressure

Compressor Block

- Cast iron cylinder with cooling fins and special aluminium alloy top heads
- Special aluminium alloy pistons and cast connecting rods
- High-strength cast iron sump
- Dynamically balanced cast steel crankshaft and counterweight

Model	Working Pressure				Inlet Capacity						Motor kW/HP	Connection	Dimensions (mm)			Weight kg
	Minimum bar - psi		Maximum bar - psi		7 bar m³/min - cfm		10 bar m³/min - cfm		13 bar m³/min - cfm				Length	Width	Height	
DBK 10	15	218	40	580	2,1	74	2,89	102	3,67	130	7,5/10	1"	1286	825	753	300
DBK 15	15	218	40	580	2,45	87	3,37	119	4,29	152	11/15	1"	1286	825	753	300
DBK 20	15	218	40	580	3,71	131	5,1	180	6,49	229	15/20	1"	1357	820	758	330
DBK 25	15	218	40	580	4,9	173	6,73	238	8,57	303	18,5/25	1 1/4"	1423	874	736	440
DBK 30	15	218	40	580	5,56	196	7,65	270	9,74	344	22/30	1 1/4"	1423	881	736	523
DBK 40	15	218	40	580	6,68	236	9,18	324	11,68	413	30/40	1 1/4"	1423	972	736	580

- Unit performances measured in reference conditions which are 1 bar absolute air Pressure, %0 relative humidity, 20°C inlet air temperature, 71°C thermostatic valve set temperature and use of Smartoil.
- Dalgakiran reserves its rights to make changes in its products and specifications without prior notice.

2,1-11,68
m³/min

7,5-30
kW

15-40
bar



General Features

- Electric motor protection to prevent overload
- Dedicated discharge system to prevent oil discharge from blow-off valve
- Energy-saving Load/Unload System
- Control panel for user-friendly operation
- Automatic discharge system for loadless start
- Air-cooled compressor units
- Gear-driven oil pump
- Star/delta motor starter
- Long life thanks to low speed operation
- Optional soft starter



Advantages

- Integrated oil pump driven by the main motor lubricates the pistons, bearings and pins efficiently.
- Improved vibration level helps to keep maintenance costs down.
- Durable sliding bearings prolong maintenance periods and keep maintenance costs low.
- High performance with the outstanding technology and design.
- Oil-trap air filtration system provides cleaner air.
- Energy-saving advanced cooling and lubrication systems.

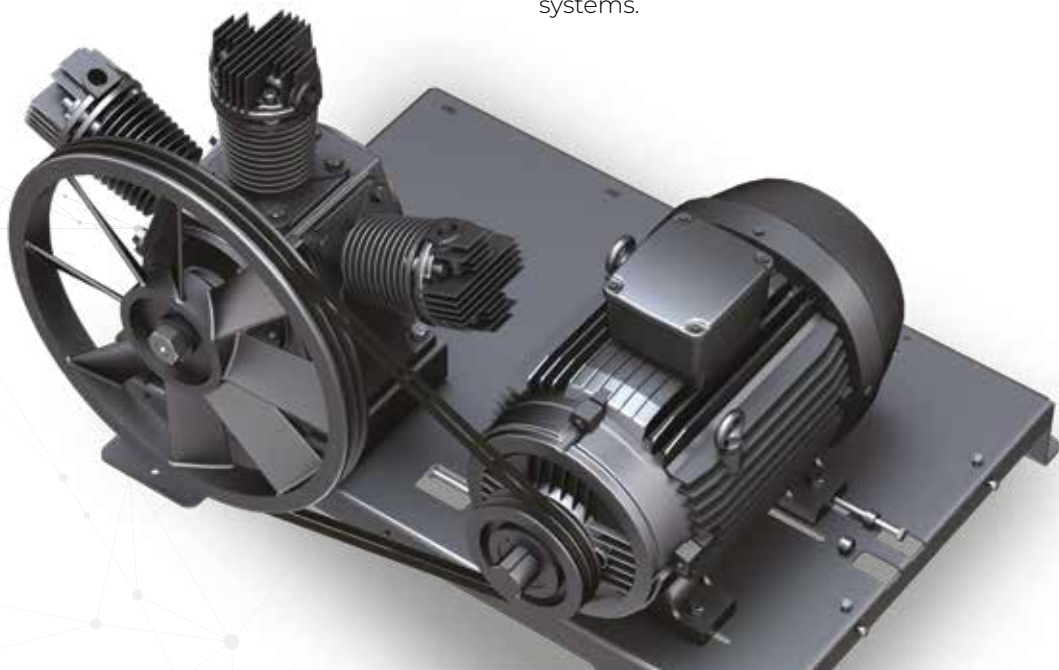



Controller

- Mains voltage and phase monitoring to protect the main motor at certain limits
- Multiple compressor control for up to 8 compressors without the need for an external master controller
- Internal ModBus communication
- Alarm log records the last 9 alarms



Main Motor and Drive System

- IE3 efficiency-class electric motors
- Belt pulley drive system
- Easy belt tensioning system
- Specially designed fan type cast iron pulley
- Star/delta motor starter
- Special loadless start system and automatic discharge system for loadless start



Compressor Block

- Cast iron cylinder with cooling fins and special aluminium alloy cylinder heads
- Specially designed long-life and high-speed stainless steel concentric valves
- High-strength cast iron crankcase
- Dynamically balanced cast steel crankshaft and counterweight
- Special aluminium alloy pistons and cast connecting rods



Model	Working Pressure				Inlet Capacity						Motor kW/HP	Connection	Dimensions (mm)			Weight kg
	Minimum bar - psi		Maximum bar - psi		7 bar m ³ /min - cfm		10 bar m ³ /min - cfm		13 bar m ³ /min - cfm				Length	Width	Height	
DBK 10 GP	15	218	40	580	2,1	74	2,89	102	3,67	130	7,5/10	1"	1430	1010	1025	389
DBK 15 GP	15	218	40	580	2,45	87	3,37	119	4,29	152	11/15	1"	1430	1010	1025	397
DBK 20 GP	15	218	40	580	3,75	132	5,15	182	6,55	231	15/20	1"	1430	1010	1025	422
DBK 25 GP	15	218	40	580	4,9	173	6,73	238	8,57	303	18,5/25	1 1/4"	1500	1025	957	465
DBK 30 GP	15	218	40	580	5,56	196	7,65	270	9,74	344	22/30	1 1/4"	1500	1025	957	535
DBK 40 GP	15	218	40	580	6,68	236	9,18	324	11,68	413	30/40	1 1/4"	1500	1025	957	594

- Unit performances measured in reference conditions which are 1 bar absolute air pressure, 0% relative humidity, 20°C inlet air temperature, 71°C thermostatic valve set temperature and use of Smartoil.

- Dalgakiran reserves its rights to make changes in its products and specifications without prior notice.

3,6-23
m³/min

37-220
kW

16-40
bar

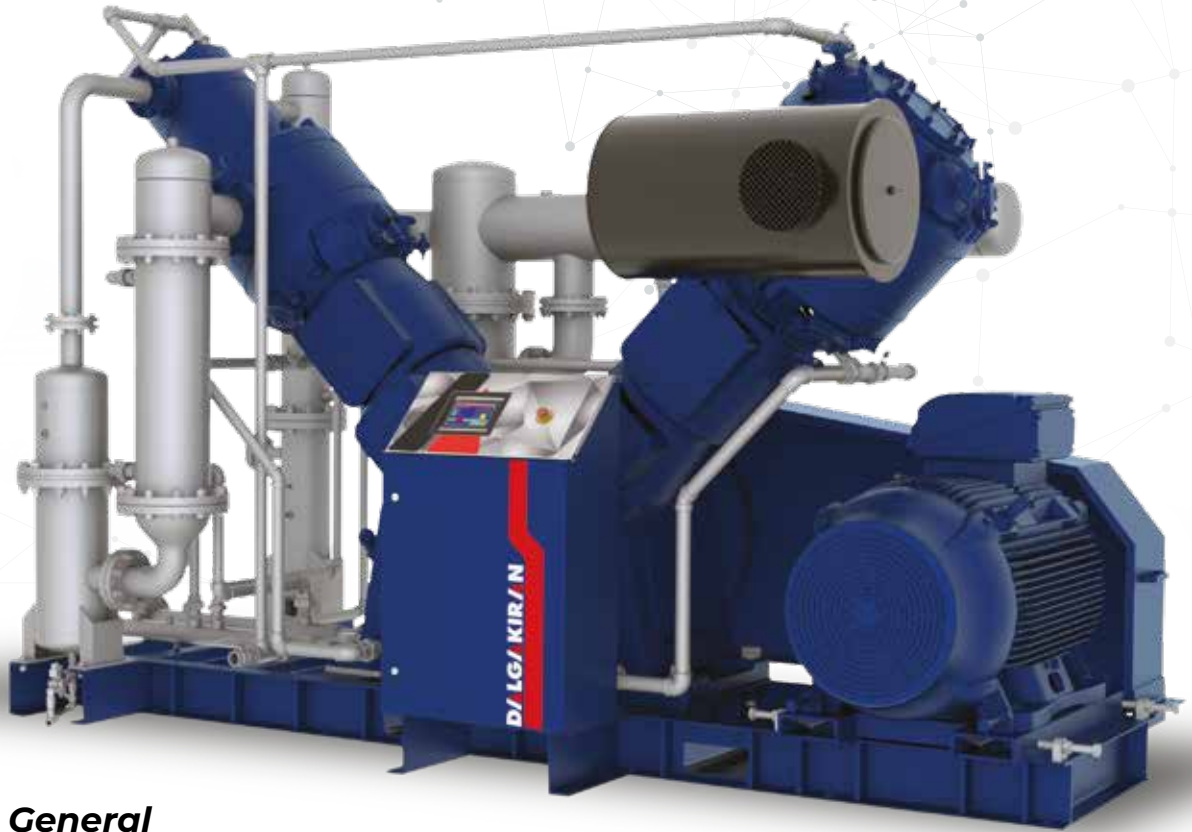

General Features

- Reciprocating compressor providing 100% oil-free industrial air
- Electric motor protection to prevent overload
- Water-cooled design for high energy efficiency and ability to work in severe conditions
- Energy-saving Load/Unload System for efficient operation
- Integrated electrical system for user-friendly operation
- 16-40 bar operating range



Advantages

- Compact structure, easy to install and assemble.
- Provides maximum oil-free air capacity in minimum space.
- Wear due to friction is minimized. This positively affects maintenance times and costs.
- Stainless steel water separator increases corrosion resistance.
- Soft start prolongs component life.





Electric Motor

- IE3 efficiency-class electric motors
- Special loadless start system and automatic discharge system for loadless start
- Long life with low RPM thanks to 6 pole feature



Compressor Block

- Water jacketed cast iron cylinders and heads
- Specially designed high-speed stainless steel concentric valves
- High-strength cast iron crankcase
- Dynamically balanced high-strength forged steel crankshaft
- Special aluminium alloy pistons and forged steel connecting rods

Model	Working Pressure		Capacity		Motor kW/HP	Connection	Dimensions (mm)			Weight kg
	bar	psi	m ³ /min	cfm			Width	Length	Height	
PET Master 50	40	580	3,6	127	37/50	G 1 1/4"	3647	1669	2395	5500
PET Master 75	40	580	5,5	194	55/75	G 1 1/4"	3647	1669	2395	5500
PET Master 100	40	580	7,4	261	75/100	G 1 1/4"	3673	1744	2470	6500
PET Master 125	40	580	9,1	321	90/125	G 1 1/4"	3673	1744	2470	6500
PET Master 150	40	580	11,6	410	110/150	G 2"	4192	1977	2814	7500
PET Master 180	40	580	13,5	477	132/180	G 2"	4192	1977	2814	7500
PET Master 220	40	580	16,4	579	160/220	G 2"	4192	1977	2814	7800
PET Master 270	40	580	21,3	752	200/270	G 2"	4234	2203	2841	9200
PET Master 300	40	580	23	812	220/300	G 2"	4234	2203	2841	9200

Model	Working Pressure		Capacity				Motor kW/HP	Connection	Dimensions (mm)			Weight kg
	bar	psi	Minimum m ³ /min	Minimum cfm	Maximum m ³ /min	Maximum cfm			Width	Length	Height	
PET Master 75 VSD	40	580	4,1	145	5,5	194	55/75	G 1 1/4"	3647	1670	2395	5600
PET Master 125 VSD	40	580	6,8	240	9,1	321	90/125	G 1 1/4"	3383	2411	2407	6650
PET Master 180 VSD	40	580	10,1	357	13,5	477	132/180	G 2"	4192	1977	2814	7750
PET Master 220 VSD	40	580	12,3	434	16,4	579	160/220	G 2"	4192	1977	2814	8000
PET Master 300 VSD	40	580	17,3	611	23	812	220/300	G 2"	4234	2203	2841	9500

- Unit performances measured in reference conditions which are 1 bar absolute air Pressure, %0 relative humidity, 20°C inlet air temperature, 71°C thermostatic valve set temperature and use of Smartoil.
- Dalgakıran reserves its rights to make changes in its products and specifications without prior notice.

507-
1657
l/min

5,5-15
kW

40
bar

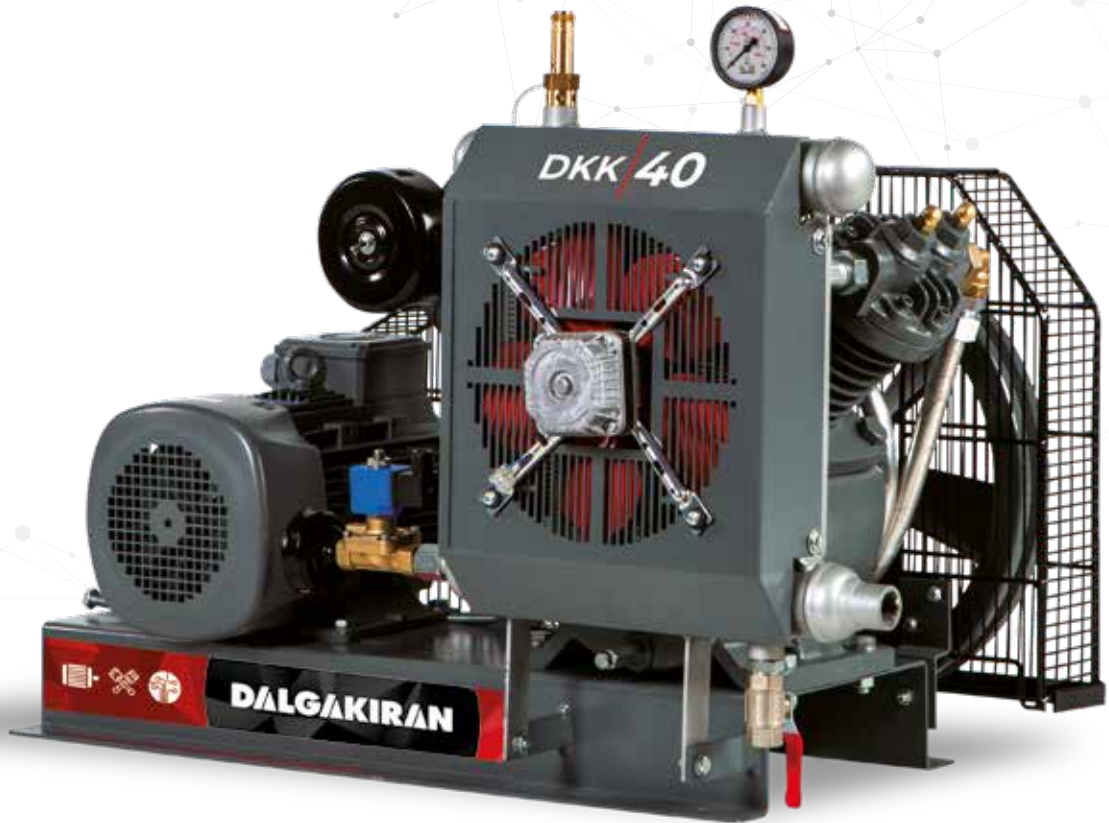

General Features

- Automatic discharge system for loadless start
- After cooler
- Air intake filter and silencer
- Includes safety systems suitable to pressure class



Advantages

- Ideal for applications requiring high pressure, particularly the maritime sector.
- High-quality components for high-efficiency operation.
- Robust cast body.
- Long-life bearings for reduced maintenance and service periods.
- Ensures compressed air needs up to 40 bar.
- Service-friendly design minimizes downtime and lowers maintenance costs.

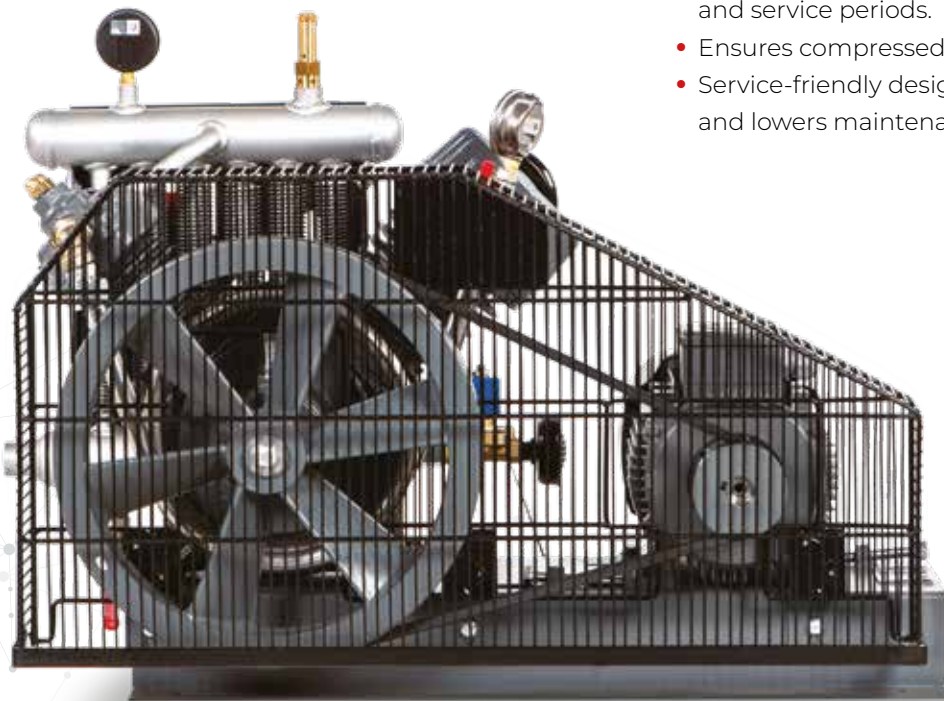



Main Motor and Drive System

- IE3 efficiency-class electric motor
- Belt-pulley drive system
- Adjustable belt tension reduces losses
- Specially designed fan-type cast iron pulley
- Easy-to-use belt-tensioning system
- Optional star/delta starter



Compressor Block

- Cast iron cylinder and cylinder heads with cooling fins
- Specially designed high-speed stainless steel concentric valves
- High-strength cast iron oil sumps
- Dynamically balanced cast steel crankshaft and counterweight
- Special aluminium alloy pistons and cast steel connecting rods
- Specially designed finger type, high-capacity stainless steel suction-discharge valves
- Stainless steel, high-pressure resistant specially designed suction-discharge valves



Safety System

- Integrated check valve in air outlet line
- Belt pulley housing guard
- High-pressure switch
- First and second stage relief valves
- Outlet pressure manometer
- First stage pressure manometer

Model	Working Pressure		Piston Displacement		Motor	Connection	Dimensions (mm)			Weight
	bar	psi	l/min.	cfm	kW/HP		Length	Width	Height	kg
DKK 40	40	580	507	17,9	5,5 / 7,5	3/4"	933	576	662	153
DKKB 40	40	580	1060	37,4	11 / 15	1"	1312	1213	718	363
DKKB 40A	40	580	1657	58,5	15 / 20	1"	1295	897	832	422

- Unit performances measured in reference conditions which are 1 bar absolute air Pressure, 0% relative humidity, 20°C inlet air temperature, 71°C thermostatic valve set temperature and use of Smartoil.
 - Dalgakiran reserves its rights to make changes in its products and specifications without prior notice.

1077-3526
l/min

11-37
kW

12-40
bar



General Features

- PLC-based control and system monitoring with digital display panel
- High efficiency motor
- Oil trap air filtration system (Optional)
- Direct coupled



Advantages

- Lightweight and robust composite cabinet provides high-performance cooling, protects the cylinder heads from impacts and prevents the operator from coming into contact with moving and hot components.
- Ease of installation and strong components for longer uptimes and user-friendly operation.
- Safe, low-maintenance operation thanks to integrated flexible coupling



Compressor Block

- Cast iron cylinder with cooling fins and special aluminium alloy cylinder heads
- High-strength cast iron crankcase
- Dynamically balanced steel crankshaft and counterweight
- Special aluminium alloy pistons and cast steel connecting rods
- Specially designed concentric-type, high-capacity stainless steel suction-discharge valves



Main Motor and Drive System

- IE3 efficiency-class electric motor
- Direct coupled with elastic coupling
- Star/delta motor starter
- Special loadless start system and automatic discharge system for loadless start
- Soft starter (optional)



Controller

- Mains voltage and frequency monitoring, protection at certain limits
- Multiple compressor control for up to 8 compressors without the need for an external master compressors
- Internal ModBus communication
- Alarm log records the last 9 alarms



Cooling System

- 4-stage radiator (3 stages for air, 1 stage for oil cooling)
- Cylinder and cylinder heads with cooling fins
- Cooling fan connected directly to the main motor

Model	Working Pressure				Piston Displacement		Voltage / Frequency		Motor	Connection	Dimensions (mm)			Weight
	Minimum bar - psi		Maximum bar - psi		l/min.	cfm	V/Hz		kW/HP		Width	Length	Height	kg
W 64	12	174	40	580	1077,3	38	400/50		11/15	1"	1300	1100	1030	411
					1447,8	51,13	460/60		15/20		1300	1100	1030	421
W 108	12	174	40	580	1806,7	63,8	400/50		15/20	1"	1300	1100	1030	421
					2210,2	78	460/60		22/30		1580	1175	1100	630
W 166	12	174	40	580	2767,4	97,6	400/50		30/40	1"	1580	1175	1100	630
					2797,2	98,8	460/60		30/40		1640			680
W 210	12	174	40	580	3526,4	124,5	400/50		37/50	1"	1640	1175	1100	680

- Unit performances measured in reference conditions which are 1 bar absolute air Pressure, %0 relative humidity, 20°C inlet air temperature, 71°C thermostatic valve set temperature and use of Smartoil.
- Dalgakiran reserves its rights to make changes in its products and specifications without prior notice.

TURBO AIR COMPRESSORS

INDEX

Turbo Compressors 48



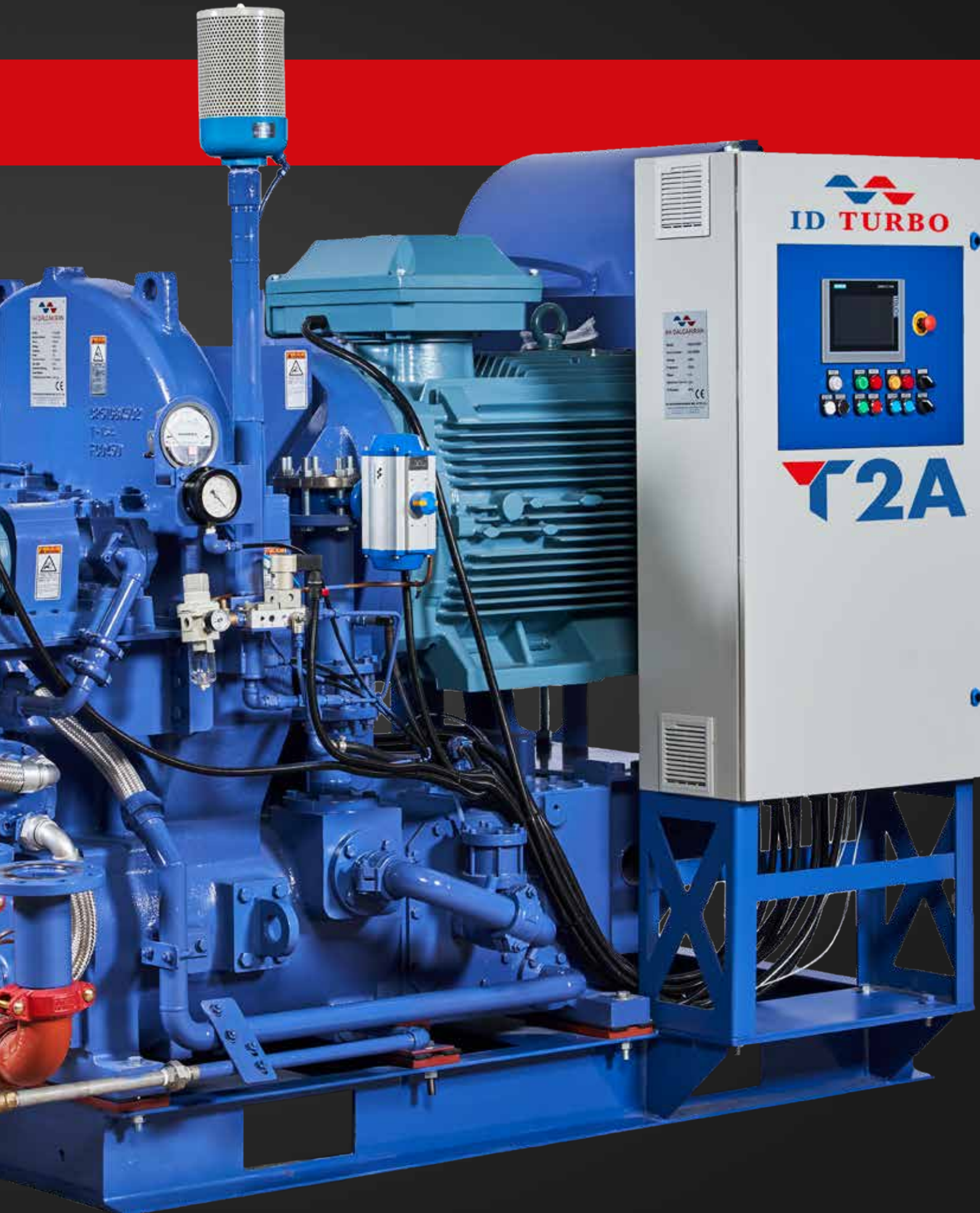



Energy Saving

For the stringent energy-saving requirements, we face today, IHI Dalgakiran provides high-level energy savings with turbo compressors using advanced rotary machine technology that provides first-class energy efficiency.



User Customization

In the manufacturing facilities, compressed air needs are constantly changing. IHI Dalgakiran Turbo Compressors are specially designed based on our customer needs, factory location and climatic conditions to provide the best solution for production operations.



Compressor Frame

The gear case and air coolers are cast together in a single, construction. The robust and compact compressor unit and air paths are surrounded by a thick, seamless wall that is also highly effective in reducing noise level and internal pressure losses.



Impellers

Designed with the power of a deep-rooted engineering experience, impellers provide the upper segment efficiency and wide operating range for users with the support of CFD technology. They are resistant to structural constraints such as corrosion and particulate abrasion, thanks to Titanium structures.



Diffusers

The kinetic energy generated by the impeller in the rotational motion enhances the system pressure by converting it into potential energy as the flow passes through the diffuser. The air flow passing through the diffuser and impeller is simulated in a coupled manner in the CFD environment to obtain a low turbulence flow profile with minimum loss and quiet.



IGV (Inlet Guide Vanes)

The compressor's inlet has vanes whose angles can be changed in order to reduce the impeller air intake. This is more effective than using a butterfly valve to add pressure loss in order to reduce airflow, and if the same airflow is discharged, the dynamic power can be kept low.



Tilting Pad Journal Bearing

In order for the high speed pinion shafts to be able to bed efficiently, they provide an even distribution of radial loads. They do not need maintenance and replacement under normal operating conditions.



Labyrinth Seal

Labyrinth seals are preferred to ensure sealing between the pressure chamber and the gearbox. The labyrinth seals provide sealing without touching the shaft. Hence it removes the friction losses due to sealing and does not need maintenance.





Suction Filter

The suction filter uses a combined type element, making it very easy to maintain. IHI Dalgakiran original design, high performance, combined filter element has pre and main filter in one element.



Various Options

Various options such as motor starter panel and group control panel can also be provided by IHI Dalgakiran upon request.



OPERATING PRINCIPLE OF THE TURBO COMPRESSOR

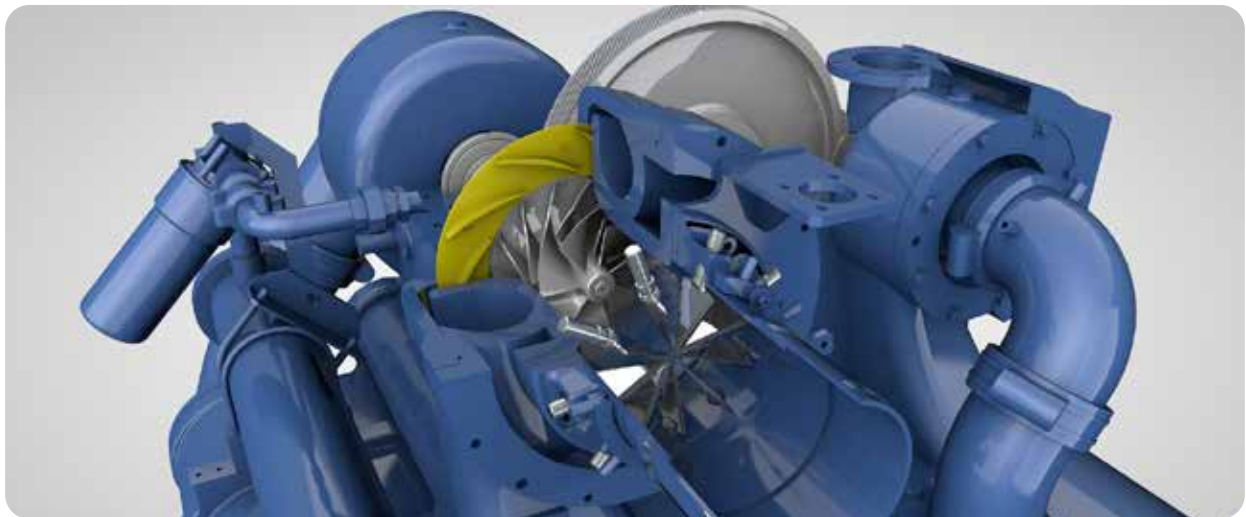

Turbo compressors are the type of compressors that provide kinetic energy to the air or gases by the centrifugal force generated by the impellers and convert this kinetic energy into pressure energy in the diffuser by reducing the air flow path. Pressurized air is cooled before entering the next stage with high performance coolers. This results in higher productivity.



Easy Maintenance

IHI Dalgakıran turbo compressors have a simple and robust design, in order to reduce maintenance costs. IHI Dalgakıran have worked hard to simplify maintenance procedures so that our products can provide a stable supply of compressed air throughout the year, with minimal maintenance.



Control Panel

IHI Dalgakıran offers advance control panel for T2A, TRA, T3A, TRE and TRX compressors with high speed and high reliability

Control panel specifications are stated as below;

- High quality touch screen with special functions
- Flexible and high resolution Analog/Digital Inputs, Outputs
- Profinet communication protocol standard, Profibus and Modbus are optional
- Adjustable capacity control methods for machine type
- Easily integrated with DCS or Scada System of the customer.



Certification

IHI Dalgakıran Turbo Compressors have been audited by an independent third party (TÜV, Germany) and received the best rating, i.e. Class 0 (100%) oil-free certificate.



Model	Motor (kW)	Pressure Range bar	Pressure Range psi	Flow Rate (m ³ /h)	Dimensions (mm)			Weight (kg)
					Length	Width	Height	
T2A	132-250	4-9	59-130	1,394-2,700	3,043	2,066	2,506	4,500
TRA	200-600	2-11	30-160	2,400-6,600	3,700-4,940	2,000-2,100	2,000-2,400	7,100-9,500
TRE	355-1,060	2-16	30-232	3,600-11,400	4,100-5,429	2,100-4,100	2,000-3,000	8,300-13,500
T3A	400-1,400	2-11	30-188	8,200-15,000	4,600-6,700	2,250-2,500	2,000-3,500	10,000-16,000
TRX	710-2,000	2-10	30-145	8,200-22,000	4,850-7,260	2,400-3,900	2,150-3,400	13,500-20,000

SERVICE & MAINTENANCE

- If compressed air is essential to your daily operations, it is vital to keep the components of your compressed air supply system well maintained.
- Each component of an air compressor has a specific function. The regular maintenance of the air compressor will ensure a better quality of compressed air and energy efficiency, further improving business productivity and profits.
- Beyond that identifying certain areas of repairs or more importantly timely interventions can help you save on energy consumption and cost.

We are at the closest point to your compressor

- We provide a worldwide network of highly qualified Dalgakiran service technicians and specially trained and authorized service partners.

We leave nothing to chance

- As Dalgakiran, we know how important quality is. Therefore, we are extremely careful and ensure that the compressor always has the right conditions to function in its plant.
- When we repair, we assess and recommend any measures regarding service life and efficiency. We also perform mechanical processing of the compressor's various components.



SPARE PARTS

- The only way to get trouble-free and long-term use of the compressor is to use only original spare parts and lubricants.
- All SmartParts products are manufactured according to original specifications for the maximum efficiency.
- Original SmartParts products provides the best operating conditions and eliminate all risks of unexpected failures from poor quality service parts. It ensures that machine works with the expected performance until the recommended part maintenance period.
- The non-stop technical support provided by our dealers and distributors in different locations around the world ensures that the machines maintain to operate under the optimum conditions.

Smart*PARTS*

INTELLIGENT SPARE PART



DALGAKIRAN

DALGAKIRAN

SCROLL
DS-3.7 S

DALGAKIRAN

DALGAKIRAN

JOURNEY OF AIR

Headquarter

Eyup Sultan Mah. Muminler Cad. No: 70 34885 Sancaktepe / Istanbul / Türkiye

Factory

Makine Ihtisas OSB, Demirciler Mah. 1. Cad. No:1/2, Merkez, Dilovası / Kocaeli / Türkiye

Tel: +90 216 311 71 81 **e-mail:** info@dalgakiran.com

D/LG/KIRAN